

Article number: 20992D42M12

Description: E+G Threaded end-caps - GN 992-D42-M12

Measures

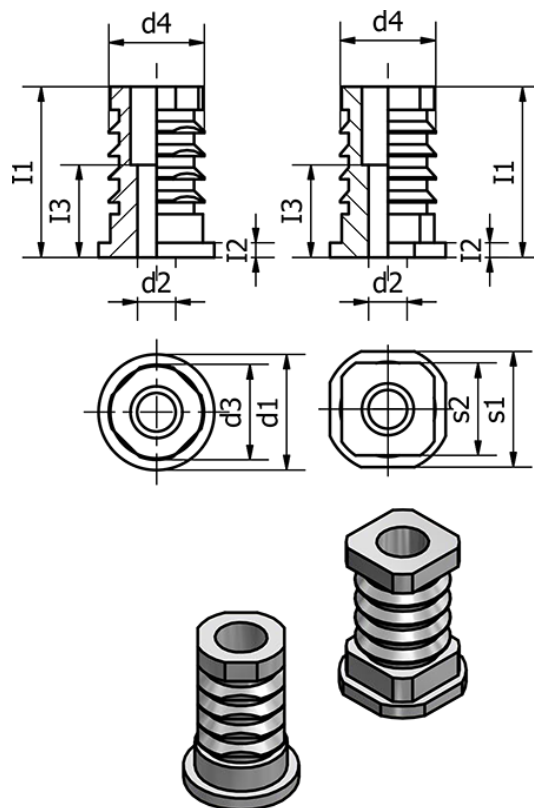

d1 = D42

d2 = 12

d3 = 36

d4 = 36.5

I1 = 41.5

I2 = 2.5

I3 = 24

s1 =

s2 =

Weight (g) = 90